

**Characteristics / Ordering Code**

The directional valve type D1SE is equipped with a wet pin armature solenoid, drain free tapered poppet and compatible with the standards DIN NG06, CETOP 03, and NFPA D03. Due to the 3/2-way design, port A is either connected with P or discharged in the tank. The neutral position (solenoid not activated) is taken automatically by a return spring. This position remains until the solenoid is energized.

The valve poppet including activation lever and the armature of the solenoid are located in the pressurized oil chamber of connection T. The valve poppet is designed such that there can be no differential area in its axial operational direction (opening, closing). Thus it is statically pressure-balanced so that the valve can be switched in both flow directions even under pressure.

The unit has an all-steel design, the important functional inner parts are hardened, the poppet and seat are grinded.

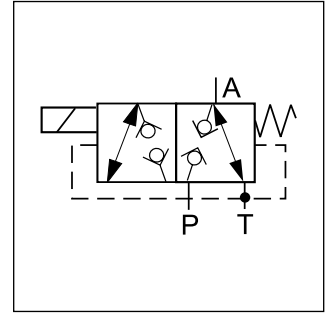

2

**Ordering code**

<b>D</b>	<b>1</b>	<b>S</b>	<b>E</b>	[ ]	<b>B</b>	[ ]	[ ]	<b>W</b>	[ ]
Directional control valve	Size DIN NG06 CETOP 03 NPPA D03	Seat valve	Wet pin armature solenoid, flanged	Spool type	Style	Seals	Solenoid voltage	Connector as per EN 175301-803 without plug <sup>1)</sup>	Design series (not required for ordering)

Code	Spool type
<b>30</b>	
<b>83</b>	

Code	Voltage
<b>K</b>	12 V=
<b>J</b>	24 V=
U <sup>2)</sup>	98 V=
G <sup>2)</sup>	205 V=

Code	Seals
<b>N</b>	<b>NBR</b>
V	FPM

**Bold letters = Short-term availability**

**Solenoids for repair**

Voltage	Ordering code
12 V=	7329700 - 12 V
24 V=	7329700 - 24 V
98 V=	7329700 - 98 V
205 V=	7329700 - 205 V

<sup>1)</sup> Please order plug separately.

<sup>2)</sup> To be used in combination with rectifier plugs at 120 VAC / 230 VAC power supply.

**Technical Data / Characteristic Curves**

2

General					
Design	Directional poppet valve				
Actuation	Solenoid				
Size	DIN NG6 / CETOP 03 / NFPA D03				
Mounting interface	DIN 24340 A6 / ISO 4401 / CETOP RP 121-H / NFPA D03				
Mounting position	Unrestricted, preferably horizontal				
Ambient temperature	[°C] -25...+60, observe permissible duty cycle				
MTTF <sub>D</sub> value	[years] 150				
Weight	[kg] 1.5				
Hydraulic					
Max. operating pressure	[bar] P, A, T: 350				
Fluid	Hydraulic oil according to DIN 51524				
Fluid temperature	[°C] -20...+60 (NBR: -25...+70)				
Viscosity permitted	[cSt] / [mm <sup>2</sup> /s] 10...500				
Viscosity recommended	[cSt] / [mm <sup>2</sup> /s] 30...80				
Filtration	ISO 4406 (1999); 18/16/13				
Flow max.	[l/min] 20				
Static / Dynamic					
Step response	[ms] Energized: approx. 50 [ms] De-energized: approx. 60				
Electrical characteristics					
Duty ratio	See diagram				
Max. switching frequency	[1/h] 2000				
Protection class	IP65 in accordance with EN 60529 (with correctly mounted plug-in connector)				
	Code	K	J	U	G
Supply voltage	[V]	12 V =	24 V =	98 V =	205 V =
Tolerance supply voltage	[%]	±10	±10	±10	±10
Current consumption	[A]	1.95	1.1	0.25	0.13
Power consumption	[W]	23.4	26.4	24.3	26.6
Solenoid connection	Connector as per EN 175301-803				
Wiring min.	[mm <sup>2</sup> ]	3 x 1.5 recommended			
Wiring length max.	[m]	50 recommended			

With electrical connections the protective conductor (PE ⊥) must be connected according to the relevant regulations.

**Performance curve Δp-Q**

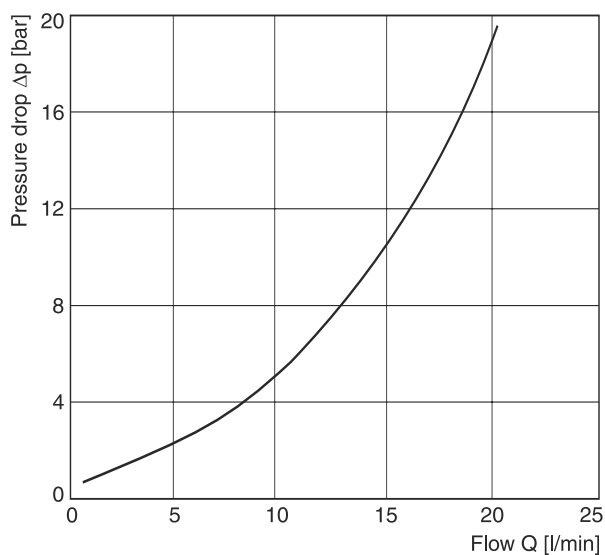



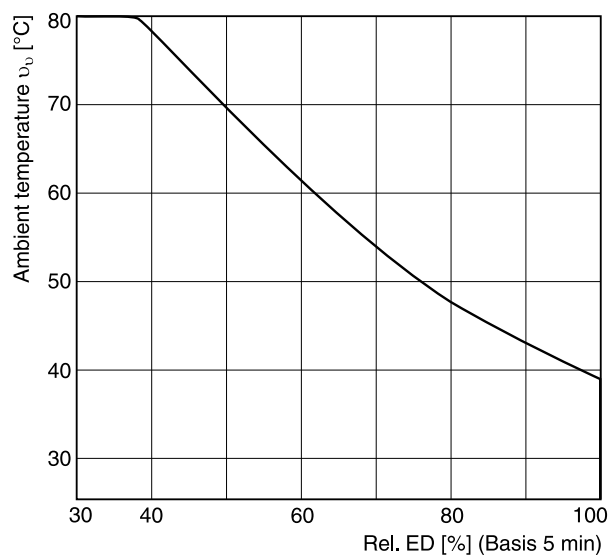

**Duty cycle versus ambient temperature**

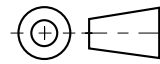
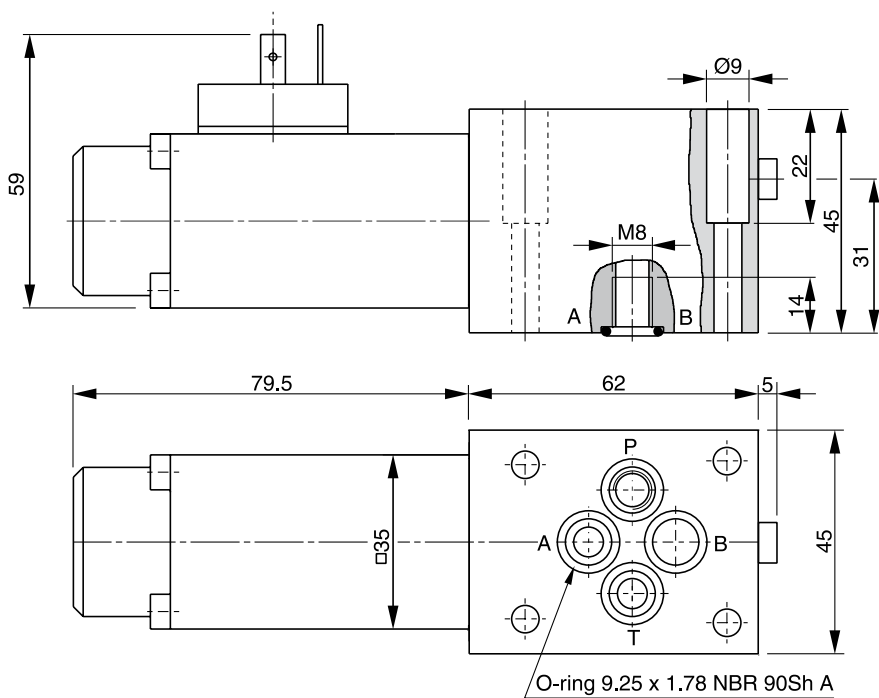

All characteristic curves measured with HLP46 at 50 °C.

**2**

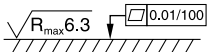

Surface finish	 Kit	 Kit	 Kit	 Kit
	BK375	4x M5x30 ISO 4762-12.9	7.6 Nm ±15 %	<b>NBR: SK-D1SE-70</b> FPM: DK-D1SE-V70

Subplates and manifolds see chapter 12.

The space necessary to remove the plug per EN 175301-803, design type AF is at least 15 mm.  
 The torque for the screw M3 of the plug has to be 0.5 to 0.6 Nm.